

Manual

Absolute Encoder with **CAN**open

Firmware version from 1.00

Contents

	Page
1. Introduction	3
1.1. Product assignment	3
2. Safety and operating instructions	4
3. CAN bus and CANopen communication	5
3.1. CAN bus	5
3.1.1. CAN bus characteristics	5
3.2. CANopen	6
3.3. CANopen communication	7
3.3.1. Communication profile	7
3.3.2. CANopen message structure	7
3.3.3. Service data communication	8
3.3.4. Process data communication	9
3.3.5. Emergency service	11
3.3.6. Network management services	12
3.4. Encoder profile	19
3.4.1. Overview of encoder objects	19
3.4.2. Detailed object list (DS-301)	23
4. Diagnosis and useful information	39
4.1. Error diagnosis field bus communication	39
4.2. Error diagnosis via field bus	39
4.3. Useful information relating to the sensor	40
5. Applications	41
5.1. Setting and reading objects	41
5.2. Configuration	42
5.3. Operation	43
5.4. Use the encoder via CAN interface	45
6. Terminal assignment and commissioning	47
6.1. Mechanical mounting	47
6.2. Electrical connection	47
6.2.1. Contact description	47
6.2.2. Pin assignment M12 connector	47
6.2.3. Pin assignment D-SUB connector	48
6.3. Display elements (status display)	48

1. Introduction

1.1. Product assignment

Shaft encoders

Product	Product code	Device name	Eds file	Product family
GBP5W	0x18	GBP5	GBP5_406.eds	Multiturn
GBP5S	0x18	GBP5	GBP5_406.eds	Multiturn
GBU5W	0x19	GBU5	GBU5_406.eds	Singleturn
GBU5S	0x19	GBU5	GBU5_406.eds	Singleturn
GXP5W	0x14	GXP5	GXP5_406.eds	Multiturn
GXP5S	0x14	GXP5	GXP5_406.eds	Multiturn
GXU5W	0x15	GXU5	GXU5_406.eds	Singleturn
GXU5S	0x15	GXU5	GXU5_406.eds	Singleturn
X 700	0x14	GXP5	GXP5_406.eds	Multiturn

2. Safety and operating instructions

Supplementary information

- This manual is intended as a supplement to already existing documentation (catalogues, product information or assembly instructions).
- The manual must be read without fail before initial commissioning of the equipment.

Intended purpose of the equipment

- The encoder is a precision measurement device. It is used to determine angular positions and revolutions, and to prepare and supply measured values in the form of electrical output signals for the follow-on device systems. The encoder may only be used for this purpose.

Commissioning

- The encoder may only be installed and assembled by suitably qualified experts.
- Observe the operating instructions of the machine manufacturer.

Safety remarks

- Prior to commissioning the equipment, check all electrical connections.
- If installation, electrical connection or any other work performed at the encoder or at the equipment is not correctly executed, this can result in a malfunction or failure of the encoder.
- Steps must be taken to exclude any risk of personal injury, damage to the plant or to the operating equipment as a result of encoder failure or malfunction by providing suitable safety precautions.
- Encoders must not be operated outside the specified limited values (see detailed product documentation).

Failure to comply with the safety remarks can result in malfunctions, personal injury or damage to property.

Transport and storage

- Only ever transport or store encoders in their original packaging.
- Never drop encoders or expose them to major vibrations.

Assembly

- Avoid impacts or shocks on the housing and shaft / hollow shaft
- Avoid any twist or torsion on the housing.
- Never make rigid connections between the encoder shaft and drive shaft.
- Do not open the encoder or make any mechanical changes to it.

The shaft, ball bearings, glass pane or electronic components can be damaged. In this case, safe and reliable operation cannot be guaranteed.

Electrical commissioning

- Do not make any electrical changes at the encoder.
- Do not carry out any wiring work when the encoder is live.
- Never plug or unplug the electrical connection when the encoder is live.
- Ensure that the entire plant is installed in line with EMC requirements. The installation environment and wiring affect the electromagnetic compatibility of the encoder. Install the encoder and supply cables separately or at a long distance from cables with high interference emissions (frequency converters, contactors etc.)
- Where working with consumers which have high interference emissions, make available a separate power supply for the encoder.
- Completely shield the encoder housing and connecting cable.
- Connect the encoder to the protective earth (PE) conductor using shielded cable. The braided shield must be connected to the cable gland or plug. Ideally, aim at bilateral connection to protective earth (PE), the housing via the mechanical assembly, the cable shield via the downstream connected devices. In case of earth loop problems, earth on one side only as a minimum requirement.

Failure to observe these instructions can result in malfunctions, material damage or personal injury.

3. CAN bus and CANopen communication

3.1. CAN bus

The CAN bus (CAN: Controller Area Network) was originally developed by Bosch and Intel as a means of fast, low-cost data transmission in automotive applications. The CAN bus is used today also in industrial automation applications.

The CAN bus is a field bus (the standards are defined by the CAN in Automation (CiA) Association) through which devices, actuators and sensors from different manufacturers can communicate with each other.

3.1.1. CAN bus characteristics

- Data rate of 1 MBaud with network expansion up to 40 m
- Network connected on both sides
- The bus medium is a twisted-pair cable
- Real time capability: Defined maximum waiting time for high-priority messages.
- Theoretically 127 users at one bus, but physically only 32 are possible (due to the driver).
- Ensures data consistency across the network. Damaged messages are notified as faulty for all network nodes.
- Message-oriented communication
The message is identified by a message identifier. All network nodes use the identifier to test whether the message is of relevance for them.
- Broadcasting, multicasting
All network nodes receive each message simultaneously. Synchronization is therefore possible.
- Multimaster capability
Each user in the field bus is able to independently transmit and receive data without being dependent upon the priority of the master. Each user is able to start its message when the bus is not occupied. When messages are sent simultaneously, the user with the highest priority prevails.
- Prioritization of messages
The identifier defines the priority of the message. This ensures that important messages are transmitted quickly via the bus.
- Residual error probability
Safety procedures in the network reduce the probability of an undiscovered faulty data transmission to below 10^{-11} . In practical terms, it is possible to ensure a 100% reliable transmission.
- Function monitoring
Localization of faulty or failed stations. The CAN protocol encompasses a network node monitoring function. The function of network nodes which are faulty is restricted, or they are completely uncoupled from the network.
- Data transmission with short error recovery time
By using several error detection mechanisms, falsified messages are detected to a high degree of probability. If an error is detected, the message transmission is automatically repeated.

In the CAN Bus, several network users are connected by means of a bus cable. Each network user is able to transmit and receive messages. The data between network users is serially transmitted.

Examples of network users for CAN bus devices are:

- Automation devices such as PLCs
- PCs
- Input and output modules
- Drive control systems
- Analysis devices, such as a CAN monitor
- Control and input devices as Human Machine Interfaces (HMI)
- Sensors and actuators

3.2. CANopen

Under the technical management of the Steinbeis Transfer Centre for Automation, the CANopen profile was developed on the basis of the Layer 7 specification CAL (CAN Application Layer). In comparison with CAL, CANopen only contains the functions suitable for this application. CANopen thus represents only a partial function of CAL optimized for the application in hand, so permitting a simplified system structure and the use of simplified devices. CANopen is optimized for fast data exchange in real time systems.

The organization CAN in Automation (CiA) is responsible for the applicable standards of the relevant profiles.

CANopen permits:

- Simplified access to all device and communication parameters
- Synchronization of several devices
- Automatic configuration of the network
- Cyclical and event-controlled process data communication

CANopen comprises four communication objects (COB) with different characteristics:

- Process data objects for real time data (PDO)
- Service data objects for parameter and program transmission (SDO)
- Network management (NMT, Heartbeat)
- Pre-defined objects (for synchronization, emergency message)

All device and communication parameters are subdivided into an object directory. An object directory encompasses the name of the object, data type, number of subindexes, structure of the parameters and the address. According to CiA, this object directory is subdivided into three different parts. Communication profile, device profile and a manufacturer-specific profile (see object directory).

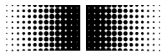

3.3. CANopen communication

3.3.1. Communication profile

Communication between the network users and the Master (PC / Control) takes place by means of object directories and objects. The objects are addressed via a 16 bit index. The CANopen communication profile DS 301 standardizes the various communication objects. They are accordingly divided into several groups:

- Process data objects PDO for real time transmission of process data
- Service data objects SDO for read/write access to the object directory
- Objects for synchronization and error display of CAN users:
 - SYNC object (synchronization object) for synchronization of network users
 - EMCY object (emergency object) for error display of a device or its peripherals
- Network management NMT for initialization and network control
- Layer Setting Services LSS for configuration by means of serial numbers, revision numbers etc. in the middle of an existing network

3.3.2. CANopen message structure

The first part of a message is the COB ID (Identifier).

Structure of the 11-bit COB ID :

Function code				Node ID						
4-bit function code				7-bit node ID						

The function code provides information on the type of message and priority
The lower the COB ID, the higher the priority of the message

Broadcast messages:

Function code	COB ID
NMT	0
SYNC	80h

Peer to peer messages:

Function code	COB ID
Emergency	80h + Node ID
PDO1 (tx) ¹⁾	180h + Node ID
PDO2 (tx) ¹⁾	280h + Node ID
SDO (tx) ¹⁾	580h + Node ID
SDO (rx) ¹⁾	600h + Node ID
Heartbeat	700h + Node ID
LSS (tx) ¹⁾	7E4h
LSS (rx) ¹⁾	7E5h

1): (tx) and (rx) from the viewpoint of the encoder

The node ID can be freely selected by means of the CANopen bus between 1 and 127 (if encoder = 0).
The encoders are supplied with the Node ID 1.
This can be changed with the service data object 2101h or using LSS.

A CAN telegram is made up of the COB ID and up to 8 bytes of data:

COB ID	DLC	Byte 1	Byte 2	Byte 3	Byte 4	Byte 5	Byte 6	Byte 7	Byte 8
Xxx	x	xx	xx	xx	xx	xx	xx	xx	xx

The precise telegram is outlined in more detail at a later point.

3.3.3. Service data communication

The service data objects correspond to the standards of the CiA. It is possible to access an object via index and subindex. The data can be requested or where applicable written into the object.

General information on the SDO

Structure of an **SDO telegram**:

COB ID	DLC	Command	Object L	Object H	Subindex	Data 0	Data 1	Data 2	Data 3
--------	-----	---------	----------	----------	----------	--------	--------	--------	--------

An SDO-**COB ID** is composed as follows:

Master -> Encoder : 600h + Node ID
 Encoder -> Master : 580h + Node ID

DLC (data length code) describes the length of the telegram. This is composed as follows:

1 byte command + 2 bytes object + 1 byte subindex + no. of data bytes (0 - 4).

The **command byte** defines whether data is read or set, and how many data bytes are involved.

SDO command	Description	Data length	
22h	Download request	Max. 4 Byte	Transmits parameter to encoder
23h	Download request	4 byte	
2Bh	Download request	2 byte	
2Fh	Download request	1 byte	
60h	Download response	-	Confirms receipt to master
40h	Upload request	-	Requests parameter from encoder
42h	Upload response	Max. 4 byte	Parameter to master with max. 4 byte
43h	Upload response	4 byte	
4Bh	Upload response	2 byte	
4Fh	Upload response	1 byte	
80h	Abort message	-	Encoder signals error code to master

An **abort message** indicates an error in the CAN communication. The SDO command byte is 80h. The object and subindex are those of the requested object. The error code is contained in bytes 5 – 8.

ID	DLC	Byte 1	Byte 2	Byte 3	Byte 4	Byte 5	Byte 6	Byte 7	Byte 8
580h + Node ID	8	80h	Object L	Object H	Subindex	ErrByte 0	ErrByte 1	ErrByte 2	ErrByte 3

Byte 8..5 results in the SDO abort message (byte 8 = MSB).

The following messages are supported:

05040001h : Command byte is not supported
 06010000h : Incorrect access to an object
 06010001h : Read access to write only
 06010002h : Write access to read only
 06020000h : Object is not supported
 06090011h : Subindex is not supported
 06090030h : Value outside the limit
 06090031h : Value too great
 08000000h : General error
 08000020h : Incorrect save signature
 08000021h : Data cannot be stored

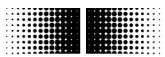
**SDO examples****Request** of a value by the master from the slave

A frequent request will be a request for position. → Object 6004h

COB ID	DLC	Command	Object L	Object H	Subindex	Data 0	Data 1	Data 2	Data 3
600h+node ID	8	40h	04h	60h	0	x	x	x	x

Response by the slave **to the request** for a value

The position is 4 bytes long, the precise values can be found under object 6004h.

COB ID	DLC	Command	Object L	Object H	Subindex	Data 0	Data 1	Data 2	Data 3
580h+node ID	8	43h	04h	60h	0	a	b	c	d

Writing of a value by the master into the slave

Position setting can be performed with preset. → Object 6003h

COB ID	DLC	Command	Object L	Object H	Subindex	Data 0	Data 1	Data 2	Data 3
600h+node ID	8	22h	03h	60h	0	a	b	c	d

Slave's **response** to the **writing of a value**

COB ID	DLC	Command	Object L	Object H	Subindex	Data 0	Data 1	Data 2	Data 3
580h+node ID	8	60h	03h	60h	0	0	0	0	0

3.3.4. Process data communication

Process data objects are used for real time data exchange for process data, for example position or operating status. PDOs can be transmitted synchronously or cyclically (asynchronously). The encoder supports the PDO1 and the PDO2. Both PDOs supply the current position of the encoder and are defined in the objects 1800h, 1801h, 1A00h, 1A01, 2800h, 2801h and 6200h.

Synchronous

In order to transmit the process data synchronously, a value between 1 and F0h (=240) must be written into the object 1800h / 1801h Subindex 2. If the value is 3, the PDO is transmitted on every third sync telegram (if the value 1 is entered, transmission takes place on every sync telegram), as long as there is a 0 written into the object 2800h / 2801h. If it contains for example a 5, the PDO will continue to be written as before on every third Sync telegram, but only a total of 5 times. Accordingly, the last PDO is written on the 15th sync telegram. The counter for the number of PDOs to be transmitted is reset in the event of a position change or NMT reset, i.e. unless it is changed, the position is transmitted five times. If the position changes, it is transmitted a further five times.

In synchronous operation, the PDO is requested by the master via the Sync telegram.

Byte 0	Byte 1
COB ID = 80	0

Cyclical (asynchronous)

If you wish the PDOs to be transmitted cyclically, the value FEh must be written into the object 1800h / 1801h Subindex 2. In addition, the cycle time in milliseconds must be entered in the same object subindex 5. The entered time is rounded off to 1 ms. If the value is stored for 0 ms, the PDOs are not transmitted. The function is switched off.

The object 2800h / 2801h offers another possibility: If the value is 0, cyclical transmission runs as described above. If the value is 1, a cyclical test is performed as to whether a change of the value has occurred. If not, no transmission takes place. If the value is 4, the PDO is transmitted four times with each cycle if there is a change.

Overview

In the following table, the different transmission modes for PDOs are summarized:

1800h		2800h	Summarized description
Sub2	Sub5		
FEh	3ms	0	Cyclical transmission every 3 ms
FEh	5ms	2	Every 5 ms, the PDO is sent twice if there is a change
FEh	0ms	0	Transmit PDO switched off
FEh	0ms	xxx	Transmit PDO switched off
3	xxx	0	Transmit with every third sync telegram
3	xxx	2Bh	On every third sync telegram, but only 43 times in total (=2Bh).

PDO (Position)

PDO1 telegram structure:

ID	DLC	Byte 1	Byte 2	Byte 3	Byte 4
181h	4	Xx	Xx	Xx	Xx

ID : 180h + node ID
 Length : 4 DataByte
 Byte1 - 4 : Current position in increments

PDO2 telegram structure:

ID	DLC	Byte 1	Byte 2	Byte 3	Byte 4
281h	4	Xx	Xx	Xx	Xx

ID : 280h + node ID
 Length : 4 DataByte
 Byte1 - 4 : Current position in increments

3.3.5. Emergency service

Internal device error or bus problems initiate an emergency message:

COB-ID	DLC	Byte0	Byte 1	Byte 2	Byte 3	Byte 4	Byte 5	Byte 6	Byte 7
80h+Node-ID	8	Error Code 00h 01h		Errorregister 1001h	Alarms 6503h		Warning 6505h		-

Byte 0..1: Error Codes

Error Code (hex)	Meaning
0000	Error Reset or No Error
1000	Generic Error
5530	EEPROM error (from V1.04+)
6010	Software reset (Watchdog) (from V1.04+)
7320	Position error (from V1.04+)
7510	Internal communication error (from V1.04+)
8130	Life Guard error or Hearbeat error (from V1.04+)
FF00	Battery low (from V1.04+)

Byte 2: Error-Register

Bit	Meaning
0	Generic Error
4	Communication error (V1.04)
7	manufacturer specific (V1.04)

Byte 3..4 Alarms

Bit	Meaning	Wert = 0	Wert = 1
0	Position error aktiv	Nein	Ja

Byte 5..6 Warning

Bit	Meaning	Wert = 0	Wert = 1
2	CPU watchdog status	OK	Reset done
4	Battery charge	OK	Battery low

Byte 7: not used

3.3.6. Network management services

Network management can be divided into two groups.

Using the NMT services for **device monitoring**, bus users can be initialized, started and stopped.

In addition, NMT services exist for **connection monitoring**.

Description of the NMT command

The commands are transmitted as unconfirmed objects and are structured as follows:

Byte 0	Byte 1	Byte 2
COB ID = 0	Command byte	Node number

The **COB ID** for NMT commands is always zero. The node ID is transmitted in byte 2 of the NMT command.

Command byte

Command byte	Description	In state event drawing
01h	Start remote node	1
02h	Stop remote node	2
80h	Enter pre-operational mode	3
81h, 82h	Reset remote node	4, 5

The **node number** corresponds to the node ID of the required users. With node number = 0, all users are addressed.

NMT state event

Following initialization, the encoder is in the pre-operational mode. In this status, SDO parameters can be read and written. In order to request PDO parameters, the encoder must first be moved to the operational mode status.

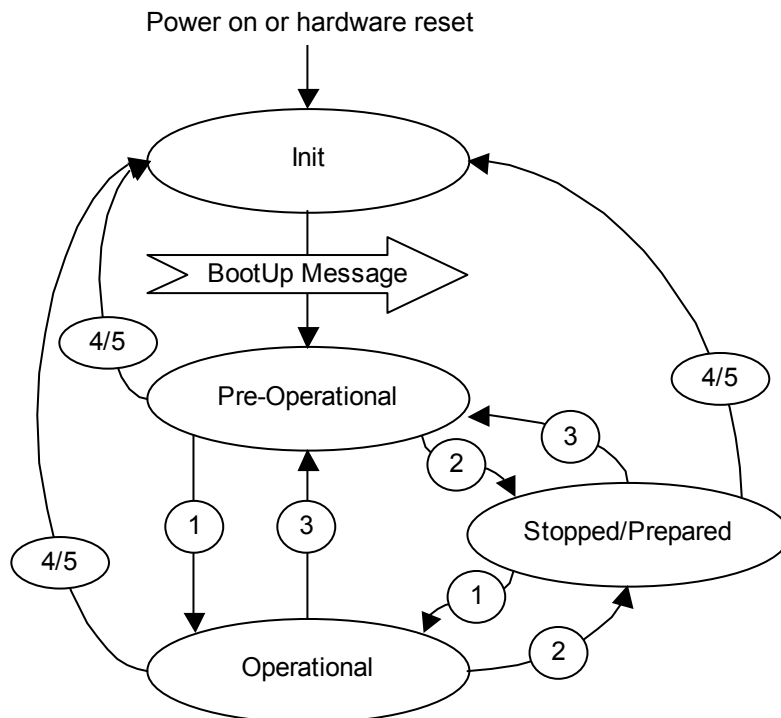

The various NMT statuses

Init

Following initialization, the encoder logs on to the CAN bus with a BootUp message. The encoder then goes automatically to the pre-operational mode status.

The COB ID of the BootUp message is made up of 700h and the node ID.

COB ID	Byte 0
700h + node ID	00

Pre-operational mode

In the pre-operational mode, SDOs can be read and written.

Operational mode

In the operational mode, the encoder transmits the requested PDOs. In addition, SDOs can be read and written.

Stopped or prepared mode

In the stopped mode, only NMT communication is possible. No SDO parameters can be read or set. LSS is only possible in the stopped mode.

Status change

Start remote node (1)

With the start command, the encoder is switched to the operational mode status.

COB ID	Command byte	Node number
0	1h	0..127

Stop remote node (2)

With the stop command, the encoder is switched to the stopped or prepared mode status.

COB ID	Command byte	Node number
0	2h	0..127

Enter pre-operational mode (3)

Change to the pre-operational mode status.

COB ID	Command byte	Node number
0	80h	0..127

Reset remote node (4) or reset communication (5)

With the reset command, the encoder is re-initialized.

Reset remote node (4):

COB ID	Command byte	Node number
0	81h	0..127

Reset communication (5):

COB ID	Command byte	Node number
0	82h	0..127

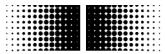

Node and Life Guarding

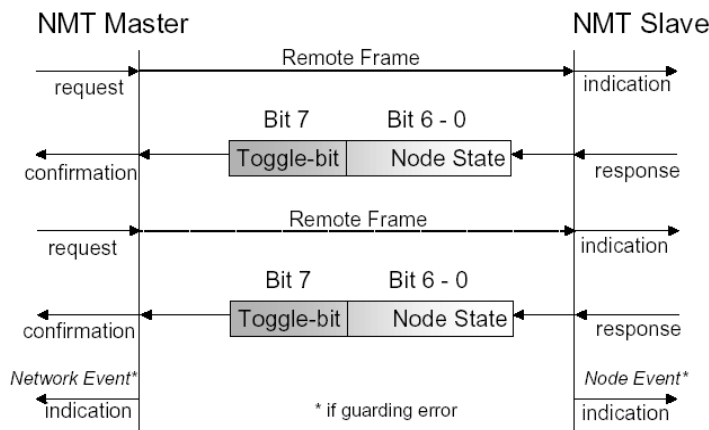
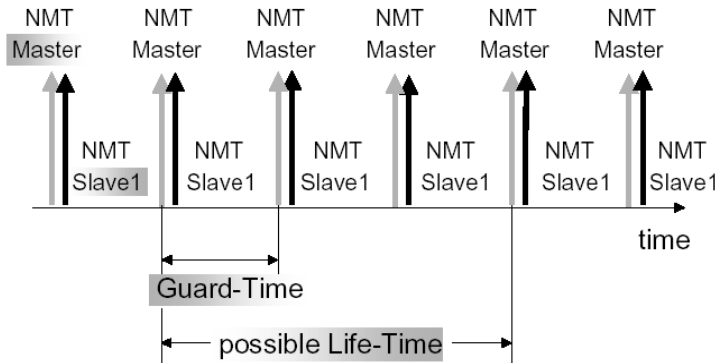

"Communication error Object 1029h-1h".

Example for a nodeguarding protocol:

COB-ID	Data/ Remote	Byte 0
701h	r	00h (0d)
701h	d	FFh (255d)
701h	r	00h (0d)
701h	d	7Fh (127d)

Possible NMT node states:

- 0: BootUp-Event
- 4: Stopped
- 5: Operational
- 127: Pre-operational

in other words, the encoder is in the pre-operational mode (7Fh = 127).

The „CAN in Automation“ association CiA recommend to use the new heartbeat protocol (see next chapter).

To use the node guarding instead of heartbeat protocol bit 5 of object 2110h has to be set.

To detect absent devices (e.g. because of bus-off) that do not transmit PDOs regularly, the NMT Master can manage a database, where besides other information the expected states of all connected devices are recorded, which is known as Node Guarding. With cyclic node guarding the NMT master regularly polls its NMT slaves. To detect the absence of the NMT master, the slaves test internally, whether the Node Guarding is taking place in the defined time interval (Life Guarding). The Node Guarding is initiated by the NMT Master in Pre-Operational state of the slave by transmitting a Remote Frame.

The NMT Master regularly retrieves the actual states of all devices on the network by a Remote Frame and compares them to the states recorded in the network database. Mismatches are indicated first locally on the NMT Master through the Network Event Service. Consequently the application must take appropriate actions to ensure that all devices on the bus will got to a save state

Heartbeat protocol

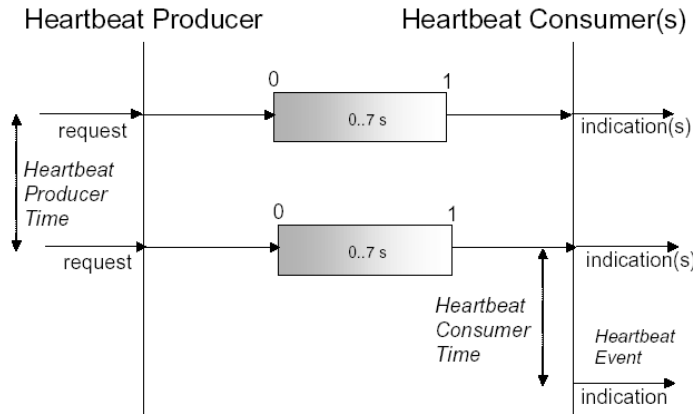

The optional heartbeat protocol should substitute the life/node guarding protocol. Heartbeat ist aktiv, wenn im Objekt 2110h Bit5 auf '0' ist. It is highly recommend to implement for new device designs the heartbeat protocol. A Heartbeat Producer transmits the Heartbeat message cyclically with the frequency defined in Heartbeat producer time object. One or more Heartbeat Consumer may receive the indication. The relationship between producer and consumer is configurable via Object Dictionary entries. The Heartbeat Consumer guards the reception of the Heartbeat within the Heartbeat consumer time. If the Heartbeat is not received within this time a Heartbeat Event will be generated "Communication error

object 1029h-1h".

Example for a heartbeat protocol

COB-ID	Data/Remote	Byte 0
701h	d	7Fh (127d)

The heartbeat messages consist of the COB ID and one byte. In this byte, the NMT status is supplied.

- 0: BootUp-Event
- 4: Stopped
- 5: Operational
- 127: Pre-operational

in other words, the encoder is in the pre-operational mode (7Fh = 127).

Attention : Only one each of the above node guarding mechanism can be set.

- Default: Heartbeat
- Optional: NodeGuarding (see object 2110)

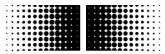

Layer Setting Services

In the spring of 2000, CiA drafted a new protocol intended to ensure standardized occurrence. The procedure is described under

Layer Setting Services and Protocol, CiA Draft Standard Proposal 305 (LSS).

The encoder is supplied by us as standard with the node ID 1 and a baud rate of 50 kBaud. Several encoders can be connected to the bus system with the same node ID. To allow individual encoders to be addressed, LSS is used.

Each encoder is fitted with its own unique serial number and is addressed using this number. In other words, an optional number of encoders with the same node ID can be connected to one bus system, and then initialized via LSS. Both the node ID and also the baud rate can be reset. LSS can only be executed in the **Stopped Mode**.

Message structure

COB ID:

Master → Slave: 2021 = 7E5h

Master ← Slave: 2020 = 7E4h

After the COB ID, an LSS command specifier is transmitted.

This is followed by up to seven attached data bytes.

COB ID	cs	Byte 1	Byte 2	Byte 3	Byte 4	Byte 5	Byte 6	Byte 7
--------	----	--------	--------	--------	--------	--------	--------	--------

Switch Mode Global

7E5h →	04h	Mode	reserved
--------	-----	------	----------

Mode : 0 → Operation mode

1 → Configuration mode

Selective switch mode

The following procedure can be used to address a certain encoder in the bus system.

7E5h →	40h	Vendor ID	reserved
--------	-----	-----------	----------

7E5h →	41h	Product code	reserved
--------	-----	--------------	----------

7E5h →	42h	Revision number	reserved
--------	-----	-----------------	----------

7E5h →	43h	Serial number	reserved
--------	-----	---------------	----------

7E4h ←	44h	Mode	reserved
--------	-----	------	----------

Vendor ID : ECh

Product code : Internal product code for the respective encoder

Revision number : Current revision number of the encoder

Serial number : Unique, consecutive serial number

Mode : The encoder's response is the new mode (0=operating mode; 1=configuration mode)

Setting the node ID

7E5h →	11h	Node ID	reserved
--------	-----	---------	----------

7E4h ←	11h	ErrCode	Spec error	reserved
--------	-----	---------	------------	----------

Node ID : The encoder's new node ID

Error code : 0=OK; 1=Node ID outside range; 2..254=reserved; 255→Specific error

Specific error : If Error code=255 → application-specific error code.

Setting the bit timing

7E5h →	13h	tableSel	tableInd	reserved
--------	-----	----------	----------	----------

7E4h ←	13h	ErrCode	SpecError	reserved
--------	-----	---------	-----------	----------

TableSel : Selects the bit timing table
 0 : Standard CiA bit timing table
 1..127 : Reserved for CiA
 128..255 : Manufacturer-specific tables
 TableInd : Bit timing entry in selected table (see table below).
 Error code : 0=OK; 1=Bit timing outside range; 2..254=reserved; 255→Specific error
 Specific error : If Error code=255 → Application-specific error code.

Standard CiA table

Baud rate	Table Index
1000 kBaud	0
800 kBaud	1
500 kBaud	2
250 kBaud	3
125 kBaud	4
100 kBaud	5
50 kBaud	6
20 kBaud	7
10 kBaud	8

Saving the configuration protocol

This protocol saves the configuration parameters in the EEPROM.

7E5h →	17h	reserved
--------	-----	----------

7E4h ←	17h	ErrCode	SpecError	reserved
--------	-----	---------	-----------	----------

Error code : 0=OK;1=Saving not supported;2=Access error;3..254=reserved;255→Specific error
 Specific error : If error code=255 → Application-specific error code.

Activate bit timing parameters

The new bit timing parameters are activated with the command specifier 15h.

7E5h →	15h	Switch delay	reserved
--------	-----	--------------	----------

Switch Delay : Reset delay in the slave in ms.
 After the delay, the encoder logs on with the new baud rate.

Request vendor ID

Requesting the vendor ID of a selected encoder

7E5h →	5Ah	reserved
--------	-----	----------

7E4h ←	5Ah	32 bit vendor ID	reserved
--------	-----	------------------	----------

Vendor ID : = ECh

Request product code

Request product code of a selected encoder

7E5h →	5Bh	reserved
--------	-----	----------

7E4h ←	5Bh	Product code	reserved
--------	-----	--------------	----------

Product code : Manufacturer-dependent product code

Request revision number

Request revision number of a selected encoder

7E5h →	5Ch	reserved
--------	-----	----------

7E4h ←	5Ch	32 bit revision number	reserved
--------	-----	------------------------	----------

Revision number : Current revision

Request serial number

Request serial number of a selected encoder

7E5h →	5Dh	reserved
--------	-----	----------

7E4h ←	5Dh	32 bit serial number	reserved
--------	-----	----------------------	----------

Serial number : Unique consecutive serial number of the encoder

Range request

Encoders can also be searched for within a certain range. For this purpose, the following objects are sent in sequence:

7E5h →	46h	Vendor ID	reserved
--------	-----	-----------	----------

7E5h →	47h	Product code	reserved
--------	-----	--------------	----------

7E5h →	48h	Revision number LOW	reserved
--------	-----	---------------------	----------

7E5h →	49h	Revision number HIGH	reserved
--------	-----	----------------------	----------

7E5h →	4Ah	Serial number LOW	reserved
--------	-----	-------------------	----------

7E5h →	4Bh	Serial number HIGH	reserved
--------	-----	--------------------	----------

Each encoder with the relevant parameters logs on with the following message:

7E4h ←	4Fh	reserved
--------	-----	----------

3.4. Encoder profile

3.4.1. Overview of encoder objects

According to CiA (CAN in Automation), objects are subdivided into three groups:

- **Standard objects:**
1000h, 1001h, 1018h
- **Manufacturer-specific objects:**
2000h - 5FFFh
- **Device-specific objects:**
All other objects from 1000h - 1FFFh, 6000h - FFFFh

The following table provides a summary of all SDO objects supported by the encoder.

Object Object number in Hex
Name ---
Type U/I = Unsigned/Integer , No. = no of bits, ARR = Array
Attr ro = read only, wo = write only, rw = read write
Default Default value on first init
EE 1 = is stored in the EEPROM
Info Additional info

Object	Name	Type	Attr	Default	EE	Info
1000h	Device type	U32	ro	00020196h 00010196h		Multiturn encoder: Byte 0..1: Profile no=196h=406 Byte 2..3: Encoder type =2 (Multiturn, absolute) Singleturn encoder: Byte 0..1: Profile no=196h=406 Byte 2..3: Encoder type =1 (Singleturn, absolute)
1001h	Error register	U8	ro	0h		Bit0=Generic Error
1003h	Predefined error field	ARR				Contains the last 8 errors or warnings
00h	Biggest subindex	U8	rw	0h		Number of stored messages (0 - 8)
01h	Last entry	U32	ro			Error or warning 1000h Generic Error 5530h EEPROM Error 6010h Software Reset (Watchdog) 7320h Positions-Error 7510h Interner Kommunikations-Error 8130h Life Guard Error or Heartbeat Error FF00h Battery low
..
08h	Oldest entry	U32	ro			Error or warning
1005h	Sync COB ID	U32	rw	80h	1	COB ID of the sync object
1008h	Device name	U32	ro	"GBP5" "GBU5" "GXP5" "GXU5"	1	"GBP5" multiturn "GBU5" singleturn "GXP5" multiturn "GXU5" singleturn
1009h	Hardware version	U32	ro	actual value		Hardware version in ASCII
100Ah	Software version	U32	ro	actual value		Software version in ASCII
100Ch	Guard Time	U16	rw	0h	1	Node Guarding Timer
100Dh	Life Time factor	U8	rw	0h	1	Multiplicator of Guard Time
1010h	Store parameters	ARR				
00h	Biggest subindex	U8	ro	4h		No. of save possibilities 4
01h	Save all parameters	U32	rw			= "save" (0x73617665) to save
02h	Communication parameters	U32	rw			= "save" (0x73617665) to save
03h	Application parameters	U32	rw			= "save" (0x73617665) to save
04h	Manuf. specific parameters	U32	rw			= "save" (0x73617665) to save
1011h	Restore default parameters	ARR				
00h	Biggest subindex	U8	ro	4h		No. of reset possibilities = 4
01h	All parameters	U32	rw			= "load" (0x6C6F6164) to load

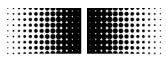

02h	Communication parameters	U32	rw			=“load“ (0x6C6F6164) to load
03h	Application parameters	U32	rw			=“load“ (0x6C6F6164) to load
04h	Manufacturer specific parameters	U32	rw			=“load“ (0x6C6F6164) to load
1014h	Emergency COB ID	U32	rw	80h +Node ID	1	COB ID of the emergency object
1016h	Consumer heart beat time	ARR				
00h	Biggest subindex		ro	1h		
01h	Consumer heartbeat time	U32	rw	10000h	1	Bit0..15 Consumer Heartbeat time in ms Bit16..23 Node-ID
1017h	Producer heartbeat time	U16	rw	0h	1	Producer Heartbeat time in ms
1018h	Identity object	U32	ro			
00h	Biggest subindex	U8	ro	4h		
01h	Vendor ID	U32	ro	ECh	1	Vendor no. issued by CiA
02h	Product Code	U32	ro	18h 19h 14h 15h	ja	18h = GBP5 Multiturn 19h = GBU5 Singleturn 14h = GXP5 Multiturn 15h = GXU5 Singleturn
03h	Revision number	U32	ro	Actual value		Current revision
04h	Serial number	U32	ro	xyz	1	Unique consecutive serial number
1029h	Error behavior	ARR				(V1.04+)
00h	Biggest subindex	U8	ro	1h		
01h	Communication error	U8	rw	1h	1	0h = change to Pre-Operational Mode 1h = no Mode-change 2h = change to Stop Mode 3h = reset node
1800h	Transmit PDO1 parameter	REC				
00h	Biggest subindex	U8	ro	5h		
01h	COB ID	U32	rw	180h+id	1	PDO ID = 180h + node ID
02h	PDO type	U8	rw	FEh	1	FEh=User defined, cyclical
05h	Event timer	U16	rw	203h	1	Cycle time in ms
1801h	Transmit PDO2 parameter	REC				
00h	Biggest subindex	U8	ro	5h		
01h	COB ID	U32	rw	280h+id	1	PDO ID = 280h + Node ID
02h	PDO type	U8	rw	2h	1	2h= synchronous operation
05h	Event timer	U16	rw	100h	1	Cycle time in ms
1A00h	Transmit PDO1 mapping	ARR				
00h	Biggest subindex	U8	ro	1h		
01h	Content of PDO1	U32	ro	60040020h		Read only, although from CiA as read write
1A01h	Transmit PDO2 mapping	ARR				
00h	Biggest subindex	U8	ro	1h		
01h	Content of PDO2	U32	ro	60040020h		Read only, although from CiA as read write
2100h	Baud rate	U8	rw	2h	1	After setting the baud rate, the EEPROM must be saved and reinitialized 0=10 kBit/s 1=20 kBit/s 2=50 kBit/s 3=100 kBit/s 4=125 kBit/s 5=250 kBit/s 6=500 kBit/s 7=800 kBit/s 8=1000 kBit/s
2101h	Node ID	U8	rw	1h	1	Node number 1 -127 possible After setting the baud rate, the EEPROM must be saved and reinitialized.

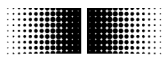

2110h	Manufactures_Options	U32	rw	1h	1	<p>Bit1 = Code sequence (object 6000h Bit0) 0 Not inverted 1 Inverted</p> <p>Bit2 = scaling function (object 6000h Bit2) 0 enabled 1 disabled</p> <p>Bit3 = 0 BusOFF not removed 1 reinstate bus after BusOFF</p> <p>Bit5 = 0 Heartbeat-Protocol enabled 1 Nodeguarding-Protocol enabled</p> <p>Bit6 = 0 normal SYNC- response 1 fast SYNC- response (see Bit 7)</p> <p>Bit7 = 0 alle PDO Modes enabled 1 only SYNC- Mode enabled → lowest Jitter (only together with set Bit 6)</p> <p>Bit8 = PDO1 Delay 2ms 0 1800h-5h = 6200h 1 1800h-5h = 6200h + 2ms</p> <p>Bit9 = Responce by write to object Resolution/overall resolution 0 Offset reset 1 Offset not reset (Version from V1.08)</p> <p>Bit10 =Response by Reset Node (from V 1.09) 0 HW Reset 1 Init NMT state</p>
2201h	Statistics	REC				
00h	Biggest subindex	U8	ro	3h		No. of subindexes
01h	No. of position errors	U32	ro	0h	1	Position control
02h	Time in seconds	U32	ro	0h	1	Time since last reset
03h	Number timer reset watchdog	U32	ro	0h	1	Timer watchdog
2300h	Customer EEPROM range	ARR				Optional data can be stored in this object
00h	Biggest subindex	U8	ro	8h		
01h	Data0	U16	rw	0h	1	
02h	Data1	U16	rw	0h	1	
03h	Data2	U16	rw	0h	1	
04h	Data3	U16	rw	0h	1	
05h	Data4	U16	rw	0h	1	
06h	Data5	U16	rw	0h	1	
07h	Data6	U16	rw	0h	1	
08h	Data7	U16	rw	0h	1	
2800h	PDO1 addition / event trigger	U8	rw	0h	1	Repeat counter for PDO1
2801h	PDO2 addition (event trigger)	U8	rw	0h	1	Repeat counter for PDO2
6000h	Operating parameter	U16	rw	4h	1	Bit0=Sense of rotation Bit2=Scaling function
6001h	Resolution	U32	rw	2000h 40000h	1	Resolution in steps / revolution: 13Bit = 8192 = GXP5, GXU5 18Bit = 262144 = = GBP5, GBU5
6002h	Overall measuring range in increments	U32	rw	(1)00000000h 40000h 20000000h 2000h	1	Overall measuring range in increments 32Bit = GBP5 Multiturn 18Bit = GBU5 Singleturn 29Bit = GXP5 Multiturn 13Bit = GXU5 Singleturn
6003h	Preset value in increments	U32	rw	0h	1	Preset in increments → Offset
6004h	Position in increments	U32	ro			Position value including offset in increments
6200h	Cyclic timer for PDO1	U16	rw	203h	1	In ms, identical object 1800h, subindex 5
6500h	Operating status	U16	ro	4h		Bit0=Sense of rotation Bit2=Scaling function
6501h	Max. resolution	U32	ro	2000h 40000h		Max. resolution in steps / revolution: 13Bit = 8192 = GXP5, GXU5 18Bit = 262144 = = GBP5, GBU5

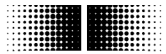

6502h	Overall measuring range in increments	U32	ro	(1)00000000h 40000h 20000000h 2000h		Overall measuring range in increments: 32Bit = GBP5 Multiturn 18Bit = GBU5 Singleturn 29Bit = GXP5 Multiturn 13Bit = GXU5 Singleturn
6503h	Alarms	U16	ro	0h		The following alarms are evaluated: Bit0=Position error
6504h	Supported alarms	U16	ro	1h		The following alarms are supported: Bit0=Position error
6505h	Warnings	U16	ro	0h		The following warnings are evaluated: Multiturn encoder: Bit2 = CPU watchdog status Bit4 = Battery charge Singleturn encoder: Bit2 = CPU watchdog status
6506h	Supported warnings	U16	ro	14h 04h		The following warnings are supported: Multiturn encoder: Bit2 = CPU watchdog status Bit4 = Battery charge Singleturn encoder: Bit2 = CPU watchdog status
6507h	Profile & software version	U32	ro	01000201h		Byte 0..1: Profile version =2.01 = 0201h Byte 2..3: Software version = 1.05 = 0105h
6508h	Operating time	U32	ro	0h		Time in 1/10 hours since last reset
6509h	Offset	U32	ro	0h	1	Offset calculated from preset → 6003h
650Bh	Serial number	U32	ro	xyz	1	Linked with serial number object 1018-4

3.4.2. Detailed object list (DS-301)

Object 1000 Device type

Subindex	0											
Data type	Unsigned 32											
Access	Read only											
Default	Multiturn: 00020196h Singleturn: 00010196h											
EEPROM	No											
Description	Information on device profile and device type											
Values	<table border="1"> <thead> <tr> <th>Data0 = Profile LOW</th> <th>Data1 = Profile HIGH</th> <th>Data2 = Type</th> <th>Data3</th> </tr> </thead> <tbody> <tr> <td>96</td> <td>01</td> <td>02</td> <td>00</td> </tr> </tbody> </table>				Data0 = Profile LOW	Data1 = Profile HIGH	Data2 = Type	Data3	96	01	02	00
	Data0 = Profile LOW	Data1 = Profile HIGH	Data2 = Type	Data3								
	96	01	02	00								
	Multiturn:											
	Data 0, 1 = 96h 01h = 0196h = DSP-406 = Device profile for encoder											
	Data 2, 3 = 02h 00h = multiturn, absolute											
Singleturn:												
<table border="1"> <thead> <tr> <th>Data0 = Profile LOW</th> <th>Data1 = Profile HIGH</th> <th>Data2 = Type</th> <th>Data3</th> </tr> </thead> <tbody> <tr> <td>96</td> <td>01</td> <td>02</td> <td>00</td> </tr> </tbody> </table>				Data0 = Profile LOW	Data1 = Profile HIGH	Data2 = Type	Data3	96	01	02	00	
Data0 = Profile LOW	Data1 = Profile HIGH	Data2 = Type	Data3									
96	01	02	00									
Data 0, 1 = 96h 01h = 0196h = DSP-406 = Device profile for encoder												
Data 2, 3 = 01h 00h = singleturn, absolute												

Object 1001 Error Register

Subindex	0		
Data type	Unsigned 8		
Access	Read only		
Default	0h		
EEPROM	No		
Description	Current error code		
Values	Bit 0	1 = Generic Error	
	Bit 4	1 = Communication error (overrun, error state)	
	Bit 7	1 = manufacturer specific	

Object 1003 Predefined error field

CiA (CAN in Automation) defines around 200 different error codes here. In this document, only the error codes of relevance for the sensor are described. This object saves the last occurred errors or warnings.

Subindex	0		
Data type	Unsigned 8		
Access	Read write		
Default	0		
EEPROM	No		
Description	Read: Number of errors or warnings Write 0: Reset error		
Values	0..8		

Subindex	1..8		
Data type	Unsigned 32		
Access	Read only		
Default	0		
EEPROM	No		
Description	Error or warning occurred, whereby subindex 1 is the ultimate, subindex 2 the penultimate entry etc.		
Values	Not yet defined		

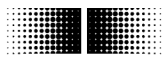
**Object 1005 COB ID SYNC message**

Subindex	0
Data type	Unsigned 32
Access	Read write
Default	80h
EEPROM	Yes
Description	Defined COB ID of the synchronization object (SYNC)
Values	Bit 31 not defined Bit 30 1=Sensor generates SYNC messages, 0=generates no SYNC message Bit 29 1=29 bit SYNC COB ID (CAN 2.0B), 0=28 bit SYNC COB ID (CAN 2.0A) Bit 28..11 Bit 28..11 of the 29 bit SYNC COB ID Bit 10..0 Bit 10..0 of the SYNC COB ID

Object 1008 Manufacturer Device Name

Subindex	0
Data type	Unsigned 32
Access	Read only
Default	"GXP5", GBP5 "GXU5", GBU5
EEPROM	No
Description	Device name in ASCII
Values	Data 0..3: "GBP5" = 47h 42h 50h 35h → GBP5 Multiturn "GBU5" = 47h 42h 55h 35h → GBU5 Singleturn "GXP5" = 47h 58h 50h 35h → GXP5 Multiturn "GXU5" = 47h 58h 55h 35h → GXU5 Singleturn

Object 1009 Manufacturer hardware version

Subindex	0
Data type	Unsigned 32
Access	Read only
Default	
EEPROM	No
Description	Hardware version in ASCII
Values	Data 0..3 example: 31h 2Eh 30h 30h = "1.00"

Object 100A Manufacturer software version

Subindex	0
Data type	Unsigned 32
Access	Read only
Default	
EEPROM	No
Description	Software version in ASCII
Values	Data 0..3 see product label exa.: 31h 2Eh 30h 30h = "1.00"

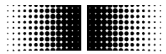

Object 100C Guard Time

Subindex	0
Data type	Unsigned 16
Access	Read write
Default	0h
EEPROM	Yes
Description	Timer for Node Guarding in ms
Values	0...65535

Object 100D Life Time Factor

Subindex	0
Data type	Unsigned 8
Access	Read write
Default	0h
EEPROM	Yes
Description	This factor multiplied by the guard time will equal the life time.
Values	0...256

Object 1010 Save parameters

Saving the objects below in the non-volatile memory (EEPROM) is initiated via object 1010h. In order to prevent unintentional saving, the message "save" must be written in subindex 1.

COB ID	DLC	Command	Object L	Object H	Subindex	Data 0	Data 1	Data 2	Data 3
600h+node ID	8	23h	10h	10h	01	73h 's'	61h 'a'	76h 'v'	65h 'e'

Objects stored in the EEPROM:

Object	Subindex	Description	Default Value (after object 1011)
1005h	0h	Sync ID	80h
1008h	0h	Device name	"GBP5" → GBP5 Multiturn "GBU5" → GBU5 Singleturn "GXP5" → GXP5 Multiturn "GXU5" → GXU5 Singleturn
100Ch	0h	Guard Time	0h
100Dh	0h	Life Time Factor	0h
1014h	0h	Emergency COB ID	80h+node ID
1016h	1	Consumer heartbeat time	10000h
1017h	0h	Producer heartbeat time	0h (disabled)
1018h	1h	Vendor ID	Ech
1018h	2h	Product code	18h → GBP5 Multiturn 19h → GBU5 Singleturn 14h → GXP5 Multiturn 15h → GXU5 Singleturn
1018h	4h	Serial Number	xyz
1029h	1h	Error Behavior	1
1800h	1h	PDO1 ID	180h+node ID
1800h	2h	PDO1 type	FEh → asynchronous, cyclical
1800h	5h	PDO1 event timer asynchronous mode	203h ms
1801h	1h	PDO2 ID	280h+node ID
1801h	2h	PDO2 type	2h → synchronous
1801h	5h	PDO2 refresh time for cyclical transmission	100h ms
2100h	0h	Baud rate	2h = 50 kBaud
2101h	0h	Node ID	1h
2110h	0h	Manufacturer Options	0x00000008
2201h	1h	No. of position errors	0h
2201h	2h	Total operating time in seconds	0h
2201h	3h	No. of timer resets by the watchdog	0h
2300h	1h	Customer-specific EEPROM range data0	0h
2300h	2h	Customer-specific EEPROM range data1	0h
2300h	3h	Customer-specific EEPROM range data2	0h
2300h	4h	Customer-specific EEPROM range data3	0h
2300h	5h	Customer-specific EEPROM range data4	0h
2300h	6h	Customer-specific EEPROM range data5	0h
2300h	7h	Customer-specific EEPROM range data6	0h
2300h	8h	Customer-specific EEPROM range data7	0h
2800h	0h	PDO1 addition (event trigger)	0h
2801h	0h	PDO2 addition (event trigger)	0h
6000h	0h	Operating parameter	0004h
6001h	0h	No. of steps per revolution	2000h → GXP5, GXU5 40000h → GBP5, GBU5
6002h	0h	Total measuring range in increments	(1)00000000h → GBP5 Multiturn 40000h → GBU5 Singleturn 20000000h → GXP5 Multiturn 2000h → GXU5 Singleturn
6003h	0h	Preset value in increments	0h
6200h	0h	Cyclical timer for PDO1	203h (see Object 1800-5)
6509h	0h	Offset	0h
650Bh	0h	Serial number	xyz (see Object 1018-4)

Object 1011 Restore parameters

The values in the RAM are overwritten by the default values (see object 1010h) by the object 1011h. In addition, the content of the EEPROM is marked as invalid. This means that until the next data save routine in the EEPROM, the default values are loaded in each case. In order to prevent unintentional overwriting, the message "load" must be written in subindex 1.

COB ID	DLC	Command	Object L	Object H	Subindex	Data 0	Data 1	Data 2	Data 3
600h+node ID	8	23h	11h	10h	01	6Ch 'l'	6Fh 'o'	61h 'a'	64h 'd'

Object 1014 COB ID emergency message

Subindex	0
Data type	Unsigned 32
Access	Read write
Default	80h+node ID
EEPROM	Yes
Description	Defines COB ID of the emergency object
Values	80h + Node ID

Object 1016 Consumer heartbeat time

Subindex	0
Data type	Unsigned 8
Access	Read only
Default	1
EEPROM	No
Description	Biggest supported subindex
Values	1 = Biggest supported subindex

Subindex	1
Data type	Unsigned 32
Access	Read write
Default	10000h
EEPROM	Yes
Description	Consumer heartbeat time
Values	Bit 0..15 Consumer heartbeat time in ms Bit 16..23 Node ID

Object 1017 Producer heartbeat time

Subindex	0
Data type	Unsigned 16
Access	Read write
Default	0h
EEPROM	Yes
Description	Defines repeat time of the heartbeat watchdog service
Values	0 = Disabled 1..65535 = Repeat time in ms

Object 1018 Identity Object

Subindex	0
Data type	Unsigned 8
Access	Read only
Default	4
EEPROM	No
Description	Biggest supported subindex
Values	4 = Biggest supported subindex

Subindex	1
Data type	Unsigned 32
Access	Read only
Default	ECh
EEPROM	Yes
Description	Vendor ID issued by CiA for IVO GmbH & Co. KG
Values	ECh (in the Internet under www.can-cia.de)
Subindex	2
Data type	Unsigned 32
Access	Read only
Default	18h → GBP5 Multiturn 19h → GBU5 Singleturn 14h → GXP5 Multiturn 15h → GXU5 Singleturn
EEPROM	Yes
Description	Product code
Values	18h → GBP5 Multiturn 19h → GBU5 Singleturn 14h → GXP5 Multiturn 15h → GXU5 Singleturn

Subindex	3								
Data type	Unsigned 32								
Access	Read only								
Default									
EEPROM	No								
Description	Revision number of the sensor								
Values	<table border="1" style="width: 100%; border-collapse: collapse;"> <thead> <tr> <th style="width: 25%;">Data 0 = Sequ. number LOW</th> <th style="width: 25%;">Data 1 = Sequ. number HIGH</th> <th style="width: 25%;">Data 2 = Version LOW</th> <th style="width: 25%;">Data 3 = Version HIGH</th> </tr> </thead> <tbody> <tr> <td style="text-align: center;">00</td> <td style="text-align: center;">00</td> <td style="text-align: center;">01</td> <td style="text-align: center;">00</td> </tr> </tbody> </table> <p>Version of the current = xxyy (xx=Version, yy=Sequence number) (see product label)</p>	Data 0 = Sequ. number LOW	Data 1 = Sequ. number HIGH	Data 2 = Version LOW	Data 3 = Version HIGH	00	00	01	00
Data 0 = Sequ. number LOW	Data 1 = Sequ. number HIGH	Data 2 = Version LOW	Data 3 = Version HIGH						
00	00	01	00						

Subindex	4
Data type	Unsigned 32
Access	Read only
Default	0
EEPROM	Yes
Description	Consecutive unique serial number of the sensor
Values	Is defined in the factory during final testing

Objekt 1029 Error Behavior (V1.04+)

Subindex	0
Data type	Unsigned 8
Access	ReadOnly
Default	1
EEPROM	No
Description	Biggest supported subindex
Values	1

Subindex	1
Data type	Unsigned 8
Access	ReadWrite
Default	1
EEPROM	Yes
Description	Behavior after communication error
Values	0h = change to Pre-Operational Mode 1h = no Mode-change 2h = change to Stop Mode 3h = reset node

Object 1800 PDO1 parameters

Subindex	0
Data type	Unsigned 32
Access	Read only
Default	5
EEPROM	No
Description	Biggest supported subindex
Values	5

Subindex	1
Data type	Unsigned 32
Access	Read write
Default	180h + Node ID
EEPROM	Yes
Description	COB ID of the PDO
Values	180h + Node ID
Subindex	2
Data type	Unsigned 8
Access	Read write
Default	FEh
EEPROM	Yes
Description	PDO type
Values	1..n..F0h = PDO has synchronous characteristics (the PDO is transmitted to each nth SYNC telegram) FEh = PDO has asynchronous characteristics (PDOs are transmitted cyclically depending on the event timer and event trigger)

Subindex	5
Data type	Unsigned 16
Access	Read write
Default	203h
EEPROM	Yes
Description	Event timer for process data object
Values	0 = Cyclical transmission switched off 1..n..65535 = Repeat time cyclical transmission equals n ms.

Object 1801 PDO2 parameters

See object 1800h, with the exception of subindex1, here COB ID is 280h + node ID

Object 1A00 PDO1 mapping

Subindex	0
Data type	Unsigned 8
Access	Read only
Default	0
EEPROM	No
Description	Biggest supported subindex
Values	1

Subindex	1
Data type	Unsigned 32
Access	Read only
Default	60040020h
EEPROM	No
Description	Describes the content of the PDO1 message
Values	6004h = Position

Object 1A01 PDO2 mapping

Subindex	0
Data type	Unsigned 8
Access	Read only
Default	0
EEPROM	No
Description	Biggest supported subindex
Values	1

Subindex	1
Data type	Unsigned 32
Access	Read only (defined by CiA as read write)
Default	60040020h
EEPROM	No
Description	Describes the content of the PDO2 message
Values	6004h = Position

Object 2100 Baud rate

Subindex	0
Data type	Unsigned 8
Access	Read write
Default	2 = 50 kBaud
EEPROM	Yes
Description	Read or reset the sensor baud rate. → After setting, parameters must be stored in the EEPROM with the object 1010h and then the sensor re-initialized.
Values	0 10 kBaud 1 20 kBaud 2 50 kBaud 3 100 kBaud 4 125 kBaud 5 250 kBaud 6 500 kBaud 7 800 kBaud 8 1000 kBaud

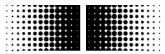
**Object 2101 Node ID**

Subindex	0
Data type	Unsigned 8
Access	Read write
Default	1
EEPROM	Yes
Description	Read or reset the node ID of the sensor. → After setting, parameters must be stored in the EEPROM with the object 1010h and then the sensor re-initialized
Values	1..127

Object 2110 Manufacturers Options

Subindex	0
Data type	Unsigned 32
Access	Read write
Default	8h
EEPROM	Yes
Description	To guarantee compatibility with older sensors some options could be defined here. This object is not supported by EDS File. Modification should be done only by vendor. Modification by customers very carefully according following table
Values	<p>Bit1 = Code sequence (Objekt 6000h Bit0)</p> <p>0 Not inverted</p> <p>1 Inverted</p> <p>Bit2 = scaling function (Objekt 6000h Bit2)</p> <p>2 enabled</p> <p>3 disabled</p> <p>Bit3 = 0 BusOFF not removed</p> <p>1 reinitate bus after BusOFF</p> <p>Bit5 = 0 Heartbeat-Protokoll enabled</p> <p>1 Nodeguarding-Protokoll enabled</p> <p>Bit6 = 0 normal SYNC- response</p> <p>1 fast SYNC- response (see Bit 7)</p> <p>Bit7 = 0 alle PDO Modes enabled</p> <p>1 only SYNC- Mode enabled</p> <p>→ lowest Jitter</p> <p>(only together with set Bit 6)</p> <p>Bit8 = PDO1 Delay 2ms</p> <p>0 1800h-5h = 6200h</p> <p>2 1800h-5h = 6200h + 2ms</p> <p>Bit9 = Responce by write to object</p> <p>Resolution/overall resolution</p> <p>0 Offset reset</p> <p>1 Offset not reset</p> <p>(Version from V1.08)</p> <p>Bit10 =Response by Reset Node (from V 1.09)</p> <p>0 HW Reset</p> <p>1 Init NMT state</p>

Object 2201 Statistics

Subindex	0
Data type	Unsigned 8
Access	Read only
Default	3h
EEPROM	No
Description	Biggest supported subindex
Values	3

Subindex	1
Data type	Unsigned 32
Access	Read only
Default	0h
EEPROM	Yes
Description	No. of position errors overall
Values	0...4294967295

Subindex	2
Data type	Unsigned 32
Access	Read only
Default	0h
EEPROM	Yes
Description	Total operating time in seconds (Object 6508h time since last reset)
Values	0... 4294967295

Subindex	3
Data type	Unsigned 32
Access	Read only
Default	0h
EEPROM	Yes
Description	Watchdog timer reset counter
Values	0... 4294967295

Object 2300 Customer EEPROM range

Subindex	0
Data type	Unsigned 8
Access	Read only
Default	8h
EEPROM	No
Description	Any optional data can be stored in this object
Values	8

Subindex	1...8
Data type	Unsigned 16
Access	Read write
Default	0h
EEPROM	Yes
Description	For each subindex, a 16 bit value can be stored (Save in the EEPROM via object 1010h)
Values	0

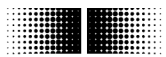

Object 2800 PDO1 addition (event trigger)

Subindex	0
Data type	Unsigned 8
Access	Read write
Default	0h
EEPROM	Yes
Description	The event trigger value determines how often the same PDO value is transmitted
Values	0 = PDO counter is switched off → Continuous transmission (time basis from the event timer) 1..n..255 = The same PDO value is transmitted n times (time basis from event timer)

Object 2801 PDO2 addition (event trigger)

Subindex	0
Data type	Unsigned 8
Access	Read write
Default	0h
EEPROM	Yes
Description	The event trigger value determines how often the same PDO value is transmitted
Values	0 = PDO counter is switched off → continuous transmission (time basis from the event timer) 1..n..255 = The same PDO value is transmitted n times (time basis from event timer)

Object 6000 Operating parameter

Subindex	0
Data type	Unsigned 16
Access	Read write
Default	4
EEPROM	Yes
Description	Operating parameter
Values	Bit 0 sense of rotation = 0 → clockwise; 1 → counterclockwise Bit 2 scaling function = 0 → max. resolution; 1 → saved resolution

Object 6001 Resolution

Subindex	0
Data type	Unsigned 32
Access	Read write
Default	2000h = 8192 = 13Bit → GXP5 / GXU5 40000h = 262144 = 18Bit → GBP5 / GBU5
EEPROM	Yes
Description	No. of steps per revolution freely selectable. ! Offset value is reset when changing the resolution!
Values	1..n.. Max. no. of steps per revolution (see object 6501) 1..n..8192 → GXP5 / GXU5 1..n..262144 → GBP5 / GBU5

Object 6002 Overall measurement range

Subindex	0
Data type	Unsigned 32
Access	Read write
Default	(1)00000000h = 4294967296 = 32Bit → GBP5 Multiturn 40000h = 262144 = 18Bit → GBU5 Singleturn 20000000h = 536870912 = 29Bit → GXP5 Multiturn 2000h = 8192 = 13Bit → GXU5 Singleturn
EEPROM	Yes
Description	Overall measurement range freely selectable in increments. Formula: Number of turns = $\frac{\text{total measuring range}}{\text{resolution}}$ Note regarding multiturn encoder operation: If the number of turns programmed is uneven 2^n (1, 2, 4,...65536) the encoder will have to be programmed anew upon having passed the zero point in powerless state.
Values	1..n.. overall measurement range in increments (see object 6502) 1..n.. 4294967296 → GBP5 Multiturn 1..n.. 262144 → GBU5 Singleturn 1..n..536870912 → GXP5 Multiturn 1..n..8192 → GXU5 Singleturn

Object 6003 Preset value

Subindex	0
Data type	Unsigned 32
Access	Read write
Default	0h
EEPROM	Yes
Description	Freely selectable position value. Preset and internal position result in offset (→ Object 6509h)
Values	0..current overall measurement range -1 (Object 6002h)

Object 6004 Position in increments

Subindex	0
Data type	Unsigned 32
Access	Read only
Default	
EEPROM	No
Description	Current position including offset
Values	0..Current overall measurement range -1 (Object 6002h)

Object 6200 Cyclic Timer for PD01

Subindex	0
Data type	Unsigned 16
Access	Read write
Default	302h
EEPROM	Yes
Description	Event timer for process data object (see object 1800-5)
Values	0 = Cyclical transmission switched off 1..n..65535 = Repeat time cyclical transmission amounts to n ms.

Object 6500 Operating Status

Subindex	0
Data type	Unsigned 16
Access	Read only
Default	4h
EEPROM	No
Description	Operating data which is written with object 6000h
Values	Bit 0 sense of rotation = 0 → Clockwise; 1 → Counterclockwise Bit 2 scaling function = 0 → max. resolution; 1 → saved resolution

Object 6501 Max. resolution in increments

Subindex	0
Data type	Unsigned 32
Access	Read only
Default	2000h = 8192 = 13Bit → GXP5 / GXU5 40000h = 262144 = 18Bit → GBP5 / GBU5
EEPROM	No
Description	Maximum singleturn resolution in increments
Values	2000h = 8192 = 13Bit → GXP5 / GXU5 40000h = 262144 = 18Bit → GBP5 / GBU5

Object 6502 Max. overall measurement range in increments

Subindex	0
Data type	Unsigned 32
Access	Read only
Default	(1)00000000h = 4294967296 = 32Bit → GBP5 Multiturn 40000h = 262144 = 18Bit → GBU5 Singleturn 20000000h = 536870912 = 29Bit → GXP5 Multiturn 2000h = 8192 = 13Bit → GXU5 Singleturn
EEPROM	No
Description	Maximum measurement range (the data type U32 in this object does not correspond to the CiA profile)
Values	(1)00000000h = 4294967296 = 32Bit → GBP5 Multiturn 40000h = 262144 = 18Bit → GBU5 Singleturn 20000000h = 536870912 = 29Bit → GXP5 Multiturn 2000h = 8192 = 13Bit → GXU5 Singleturn

Object 6503 Alarms

Subindex	0
Data type	Unsigned 16
Access	Read only
Default	0h
EEPROM	No
Description	Alarm messages as per object 6504h
Values	Bit 0 = 1 → Position error active

Object 6504 Supported alarms

Subindex	0
Data type	Unsigned 16
Access	Read only
Default	1h
EEPROM	No
Description	Alarm messages supported by object 6503
Values	Bit 0 = Position error

Object 6505 Warnings

Subindex	0
Data type	Unsigned 16
Access	Read only
Default	0h
EEPROM	No
Description	Warnings as per object 6506h
Values	Multiturn: Bit 2 = 1 → CPU watchdog reset Bit 4 = 1 → Battery charge too low Singleturn: Bit 2 = 1 → CPU Watchdog reset

Object 6506 Supported warnings

Subindex	0
Data type	Unsigned 16
Access	Read only
Default	Multiturn: 14h Singleturn: 04h
EEPROM	No
Description	Warnings supported by object 6505h
Values	Multiturn: Bit 2 = CPU watchdog status Bit 4 = Battery charge Singleturn: Bit 2 = CPU watchdog status

Object 6507 Profiles and software versions

Subindex	0								
Data type	Unsigned 32								
Access	Read Only								
Default	01000201h								
EEPROM	No								
Description	Version of the profile and the current software								
Values	<table border="1" data-bbox="501 1043 1359 1169"> <thead> <tr> <th>Data0 = Profile version LOW</th> <th>Data1 = Profile version HIGH</th> <th>Data2 = Software version LOW</th> <th>Data3 = Software version HIGH</th> </tr> </thead> <tbody> <tr> <td>01</td> <td>02</td> <td>00</td> <td>01</td> </tr> </tbody> </table> <p>Version of the current software = xxyy (xx = Software version, yy = Profile version)</p> <p>Data 0,1 = 01h 02h = 0201h = Profile version Data 2,3 = 00h 01h = 0100h = Software version (see product label)</p>	Data0 = Profile version LOW	Data1 = Profile version HIGH	Data2 = Software version LOW	Data3 = Software version HIGH	01	02	00	01
Data0 = Profile version LOW	Data1 = Profile version HIGH	Data2 = Software version LOW	Data3 = Software version HIGH						
01	02	00	01						

Object 6508 Operating time

Subindex	0
Data type	Unsigned 32
Access	Read only
Default	0h
EEPROM	No
Description	Operating time in 1/10 hours, since the last sensor reset
Values	0..n..4294967295 = n * 6 minutes operating time without reset

Object 6509 Offset

Subindex	0
Data type	Unsigned 32
Access	Read only
Default	0h
EEPROM	Yes
Description	Calculated from preset (→ Object 6003h)
Values	0..current overall measurement range -1

Object 650B Serial number

Subindex	0
Data type	Unsigned 32
Access	Read only
Default	xyz
EEPROM	Yes
Description	Progressive serial number
Values	0..4294967295 = Is directly linked with the serial number of the end test (see object 1018-4)

4. Diagnosis and useful information

4.1. Error diagnosis field bus communication

- If the encoder cannot be addressed via the CANopen bus, first of all check the terminals.

If the terminals are not in order, field bus operation should be tested next. For this purpose, a CAN monitor is required which records CANopen communication and shows the telegrams.

- The encoder should now place a BootUp message when switching the power supply off and on again.

Should no BootUp message appear, check whether the baud rates of the encoder, the CAN monitor and the bus system are in agreement.

- If you have difficulty in establishing the connection to the user, check the node number and baud rate.

The baud rate must be set the same throughout. The node number (node ID, node address) must be between 1 and 127. Each bus user must be unambiguously assigned a node ID, i.e. it is strictly prohibited to assign the same node ID more than once.

The node ID and baud rate can also be set conveniently using the LSS service.

4.2. Error diagnosis via field bus

The encoder has at its disposal several objects and messages which transcribe the status or error status of the encoder.

- Object 1001h: This object is an error register for the device error status.
- Object 1003h: In this object, the last eight error codes and warnings are stored.
- Object Emergency (80h + Node ID): High-priority error message of a user with error code and error register.
- SDO abort message: If SDO communication does not run correctly, the SDO response contains an abort code.

Object 1001h error register

The existence of a device error and its type are indicated in this register.

See separate Object descriptions

Object 1003h predefined error field

In this object, the eight last occurring error codes from objects 6503h and 6505h are saved, whereby the latest error is stored in subindex 1 and the oldest error in subindex 8.

Object emergency

Error message of a user.

SDO abort message

If SDO communication is not running smoothly, an abort code is transmitted as the SDO response:

05040001h	: Command byte is not supported
06010000h	: Incorrect access to an object
06010001h	: Read access to write only
06010002h	: Write access to read only
06020000h	: Object is not supported
06090011h	: Subindex is not supported
06090030h	: Value outside limits
06090031h	: Value too great
08000000h	: General error
08000020h	: Incorrect save signature ("save")
08000021h	: Data cannot be saved

Service address

Baumer IVO GmbH & Co. KG
Dauchinger Str. 58-62
DE-78056 Villingen-Schwenningen
info.de@baumerivo.com
www.baumerivo.com

4.3. Useful information relating to the sensor**Resetting the node ID**

1. The node ID is reset using the Baumer IVO-specific object 2100h.
2. After setting the node ID, this must be saved in the EEPROM with object 1010h.
3. On next initialization, the sensor logs on with the new node ID.

Resetting the baud rate

1. The baud rate is reset with the Baumer IVO-specific object 2101h.
2. After setting the baud rate this must be saved in the EEPROM with object 1010h.
3. On next initialization, the sensor logs on with the new baud rate.
4. **! DO NOT FORGET TO SET THE MASTER TO THE NEW BAUD RATE !**

Shielding

As the encoder is not always connected to a defined earth potential depending on its mounting position, the encoder flange should always be additionally linked to earth potential. The encoder should always on principle be connected to a shielded conductor.

If possible the cable shield should be in place at both ends. Ensure that no equalizing currents are discharged via the encoder.

5. Applications

5.1. Setting and reading objects

In order to overwrite an object (SDO) or to read it, two telegrams always have to be transmitted.

Object setting

First, the master transmits the value to be set. The encoder then transmits the confirmation.

Value (ba) is transmitted:

COB ID	DLC	Command	Object L	Object H	Subindex	Data 0	Data 1	Data 2	Data 3
600h+node ID	8	2Bh	00h	23h	3h	a	b	x	x

Confirmation:

COB ID	DLC	Command	Object L	Object H	Subindex	Data 0	Data 1	Data 2	Data 3
580h+node ID	8	60h	00h	23h	3h	0	0	0	0

Read object

First the master transmits a request for the required object. Then the encoder transmits the requested value.

Request from master:

COB ID	DLC	Command	Object L	Object H	Subindex	Data 0	Data 1	Data 2	Data 3
600h+node ID	8	40h	04h	60h	0h	x	x	x	x

Response (dcb) of the encoder to the request:

COB ID	DLC	Command	Object L	Object H	Subindex	Data 0	Data 1	Data 2	Data 3
580h+node ID	8	43h	04h	60h	0h	a	b	c	d

Commissioning

When the encoder is connected to the bus, it logs on with a BootUp message. The encoder must now be adjusted to its environment and configured.

Changing the node ID and baud rate with LSS

The node ID and baud rate can be changed without having to use these to address the encoder. With the LSS service, the sensors are addressed and configured via the product code, revision no., vendor ID and serial number.

Changing the node ID (node no.)

The node ID can be changed in object 2101h between 1 and 127. A save routine should then be executed using object 1010h. On the next initialization, the encoder logs on with the new node ID.

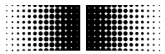

Changing the baud rate

The baud rate can be changed in the object 2100h. An index is written into the object, not the effective baud rate.

	Baud rate
0	10 kBaud
1	20 kBaud
2	50 kBaud
3	100 kBaud
4	125 kBaud
5	250 kBaud
6	500 kBaud
7	800 kBaud
8	1000 kBaud

The baud rate now still has to be saved using object 1010-1. On next initialization, the encoder logs on to the new baud rate. However, before this the baud rate of the master should be changed.

5.2. Configuration

Position setting

The value is transmitted:

COB ID	DLC	Command	Object L	Object H	Subindex	Data 0	Data 1	Data 2	Data 3
600h+node ID	8	23h	03h	60h	0h	a	b	c	d

Conformation:

COB ID	DLC	Command	Object L	Object H	Subindex	Data 0	Data 1	Data 2	Data 3
580h+node ID	8	60h	03h	60h	0h	0	0	0	0

Changing the sense of rotation and scaling

The sense of rotation can be set to CW (clockwise) or CCW (counterclockwise). In addition, the scaling can be switched on or off in the same object (6000h). With the scaling switched on, the set resolutions are used. However, if the scaling is switched off, the encoder works with the maximum resolution settings (6501h and 6502h).

- Bit 0: 0 -> CW (clockwise) Value: 0
- 1 -> CCW (counterclockwise) Value: 1
- Bit 2: 0 -> Scaling off Value: 0
- 1 -> Scaling on Value: 4

Counterclockwise rotation and scaling on:

COB ID	DLC	Command	Object L	Object H	Subindex	Data 0	Data 1	Data 2	Data 3
600h+node ID	8	23h	00h	60h	0h	5h	x	x	x

Confirmation:

COB ID	DLC	Command	Object L	Object H	Subindex	Data 0	Data 1	Data 2	Data 3
580h+node ID	8	60h	00h	60h	0h	0	0	0	0

Changing singleturn resolution

In object 6001h, the singleturn resolution can be configured. For example 1024 (10bit) steps per revolution (1024 = 400h):

COB ID	DLC	Command	Object L	Object H	Subindex	Data 0	Data 1	Data 2	Data 3
600h+node ID	8	23h	01h	60h	0h	00	04	00	00

Confirmation:

COB ID	DLC	Command	Object L	Object H	Subindex	Data 0	Data 1	Data 2	Data 3
580h+node ID	8	60h	01h	60h	0h	0	0	0	0

Changing the overall resolution

In object 6002h, the overall resolution can be set. The overall resolution and the singleturn resolution result in the number of revolutions. Example: The singleturn resolution is set at 10 bit (1024 steps) and the overall resolution at 22 bit (4194304), resulting in 4096 (12bit) revolutions of 1024 (10bit) steps each.

Setting the overall resolution to 4194304 (4194304 = 400000h)

COB ID	DLC	Command	Object L	Object H	Subindex	Data 0	Data 1	Data 2	Data 3
600h+node ID	8	23h	02h	60h	0h	00	00	40	00

Confirmation:

COB ID	DLC	Command	Object L	Object H	Subindex	Data 0	Data 1	Data 2	Data 3
580h+node ID	8	60h	02h	60h	0h	0	0	0	0

Saving the setting in the EEPROM

Object 1010h initiates the save routine for the objects below in the non-volatile memory (EEPROM). In order to prevent unintentional saving, the message "Save" must be written in Subindex 1.

COB ID	DLC	Command	Object L	Object H	Subindex	Data 0	Data 1	Data 2	Data 3
600h+node ID	8	23h	10h	10h	01h	73 's'	61 'a'	76 'v'	65 'e'

COB ID	DLC	Command	Object L	Object H	Subindex	Data 0	Data 1	Data 2	Data 3
580h+node ID	8	60h	10h	10h	01h	0	0	0	0

5.3. Operation

NMT statuses

Once the encoder has been initialized, it is then in the **Pre-operational mode**. In this mode, SDO can be read and written.

In order to start PDO communication, you must transmit an **NMT start**. The encoder is then in the **Operational mode**. Any required PDOs are then transmitted. SDOs can also be read and written.

If the encoder is stopped with an **NMT stop**, the encoder is then in the **stopped mode**. In this mode, only NMT communication is the possible, i.e. also heartbeat.

By means of an **NMT reset** the encoder is re-initialized and is then once again in the **pre-operational mode**.

Reading the position

Request from the master:

COB ID	DLC	Command	Object L	Object H	Subindex	Data 0	Data 1	Data 2	Data 3
600h+node ID	8	40h	04h	60h	0	0	0	0	0

Response (dcba) of the encoder to the request:

COB ID	DLC	Command	Object L	Object H	Subindex	Data 0	Data 1	Data 2	Data 3
580h+node ID	8	43h	04h	60h	0	a	b	c	d

Configuring PDOs

The PDOs can be configured in accordance with the following table:

1800h		2800h	Summarized description
Sub2	Sub5		
FEh	3ms	0	Cyclical transmission every 3 ms
FEh	5ms	2	Every 5ms the PDO is sent double if a change has occurred.
FEh	0ms	0	Transmit PDO switched off
FEh	0ms	xxx	Transmit PDO switched off
3	xxx	0	Transmit with each third sync telegram
3	xxx	2Bh	With each sync telegram but in total only 43 times (=2Bh).

Defining heartbeat time

In order to monitor communication capability, the heartbeat time must be defined in object 1017h with "Producer heartbeat time". As soon as the value has been confirmed, the service begins transmission.

Example:

Every 100 ms, the encoder should transmit a heartbeat (100 = 64h):

COB ID	DLC	Command	Object L	Object H	Subindex	Data 0	Data 1
600h+node ID	8	2Bh	17h	10h	0h	64h	0h

Confirmation:

COB ID	DLC	Command	Object L	Object H	Subindex	Data 0	Data 1
580h+node ID	8	60h	17h	10h	0h	0	0

COB ID	Data/ Remote	Byte 0
701h	d	7Fh

The heartbeat messages are made up of the COB ID and one byte. IN this byte, the NMT status is supplied.

- 0: BootUp-Event
- 4: Stopped
- 5: Operational
- 127: Pre-operational

i.e. the encoder is in the pre-operational modus (7Fh = 127).

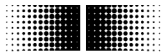

5.4. Use the encoder via CAN interface

Easy use of the CANopen encoder as CAN device via CAN (Layer 2)

Example: Encoder Node ID 1

Used Tool: CANAnalyser32 by Fa. IXXAT

Nr	ID (hex)	Name	Description	RTR	Data (hex)
1 (byt)				0	
2 (byt)	601	SDO	read total measuring range	0	40 02 60 00
3 (byt)	601	SDO	set total measuring range	0	22 02 60 00 00 00 00 10
4 (byt)	601	SDO	read singleturn resolution	0	40 01 60 00
5 (byt)	601	SDO	set singleturn resolution	0	22 01 60 00 00 10 00 00
6 (byt)	601	SDO	read position	0	40 04 60 00
7 (byt)	601	SDO	set Preset (Position to 0)	0	22 03 60 00 00 00 00 00
8 (byt)	601	SDO	read Cyclic timer	0	40 00 62 00 00
9 (byt)	601	SDO	set Cyclic timer to 5 ms	0	28 00 62 00 05 00 00 00
10 (byt)				0	
11 (byt)	601	SDO	read Node ID	0	40 01 21 00
12 (byt)	601	SDO	set Node ID to 2	0	28 01 21 00 02 00 00 00
13 (byt)				0	
14 (byt)	601	SDO	read baudrate	0	40 00 21 00 00 00 00 00
15 (byt)	601	SDO	set baudrate to 250Kbit/s	0	28 00 21 00 05 00 00 00
16 (byt)				0	
17 (byt)	601	SDO	save in eeprom	0	23 10 10 01 73 61 76 65
18 (byt)	601	SDO	restore alle parameter	0	23 11 10 01 6C 6F 61 64
19 (byt)				0	
20 (byt)	601	SDO	read alarms	0	40 03 65 00 00 00 00 00
21 (byt)	601	SDO	read warnings	0	40 05 65 00 00 00 00 00
22 (byt)				0	
23 (byt)	0	NMT	set Operational Node 1 (RUN)	0	01 01
24 (byt)	0	NMT	set Preoperational Node 1	0	80 01
25 (byt)	0	NMT	Stopp Node 1	0	02 01
26 (byt)	0	NMT	Reset Node 1	0	81 01
27 (byt)				0	
28 (byt)	601	SDO	set total measuring range	0	22 02 60 00 00 00 00 10

= 0x100000

= 0x1000

works after next Power Off/On

Load Default-Parameter values

see chapter Network management services

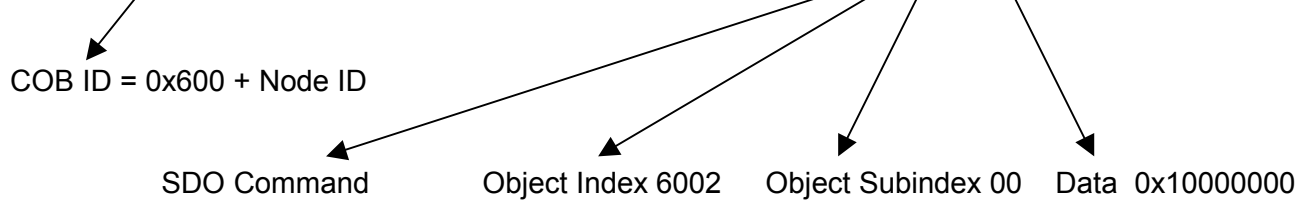

For more detailed description see chapter ,service data communication'

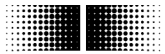

Trace view of CAN-telegrams to and from encoder

(commands see page before)

ID (hex)	Name	Data (hex)	ASCII
701		00	.
601	SDO	40 02 60 00	@.
581		43 02 60 00 00 00 00 20	C.
601	SDO	22 02 60 00 00 00 00 10	".
581		60 02 60 00 00 00 00 00
601	SDO	40 01 60 00	@.
581		43 01 60 00 00 20 00 00	C.
601	SDO	22 01 60 00 00 10 00 00	".
581		60 01 60 00 00 00 00 00
601	SDO	40 04 60 00	@.
581		43 04 60 00 C9 CA 03 00	C. EE.
601	SDO	22 03 60 00 00 00 00 00	".
581		60 03 60 00 00 00 00 00
601	SDO	40 00 62 00 00	@.b.
581		4B 00 62 00 03 02 00 00	K.b.....
601	SDO	2B 00 62 00 05 00 00 00	+ .b.....
581		60 00 62 00 00 00 00 00	\.b.....
601	SDO	40 01 21 00	@.!
581		4F 01 21 00 01 00 00 00	O.!.
601	SDO	2B 01 21 00 02 00 00 00	+ .!.
581		60 01 21 00 00 00 00 00	\.!.
601	SDO	40 00 21 00 00 00 00 00	@.!.
581		4F 00 21 00 02 00 00 00	O.!.
601	SDO	2B 00 21 00 05 00 00 00	+ .!.
581		60 00 21 00 00 00 00 00	\.!.
601	SDO	23 10 10 01 73 61 76 65	#. . . save
581		60 10 10 01 00 00 00 00	\.
601	SDO	23 11 10 01 6C 6F 61 64	#. . . load
581		60 11 10 01 00 00 00 00	\.
601	SDO	40 03 65 00 00 00 00 00	@.e.
581		4B 03 65 00 00 00 00 00	K.e.
601	SDO	40 05 65 00 00 00 00 00	@.e.
581		4B 05 65 00 00 00 00 00	K.e.
0	NMT	01 01	..
181		92 95 07 00
181		92 95 07 00
181		92 95 07 00
181		92 95 07 00
0	NMT	80 01
0	NMT	02 01
0	NMT	81 01
701		00	.

Boot up after Power on

SDO request to encoder
COB ID = 0x600+Node ID

SDO response from encoder
COB ID = 0x580+Node ID

Encoder in state Operational

Run, transmitting cyclic Position-Data
COB ID = 0x180 + Node ID

Encoder in state Pre-operational

Encoder in state Stopped

Encoder Reset

Boot up Message
COB ID = 0x700+Node ID

6. Terminal assignment and commissioning

6.1. Mechanical mounting

Shaft encoder

- Mount the encoder housing using the fastening holes on the flange side with screws (square flange with four screws), paying attention to the thread diameter and thread depth.
- Alternatively, the encoder can be mounted in any angular position using three eccentric fastenings – see accessories.
- Connect the drive shaft and encoder shaft using a suitable coupling. The ends of the shafts must not be touching. The coupling must be capable of compensating for displacement due to temperature and mechanical backlash. Pay attention to the admissible axial or radial shaft loads. For suitable connecting devices, see under accessories.
- Tighten the fastening screws.

6.2. Electrical connection

6.2.1. Contact description

Pin	Assignment
CAN_L	CAN bus signal (dominant Low)
CAN_H	CAN bus signal (dominant High)
UB	Supply voltage 10...30 VDC
GND B	Ground terminal for UB
CAN_GND	Optional: GND for CAN Interface

6.2.2. Pin assignment M12 connector

Pin	Assignment
1	GND B
2	UB
3	CAN_GND
4	CAN_H
5	CAN_L

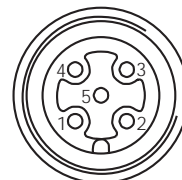

6.2.3. Pin assignment D-SUB connector

Pin	Assignment
1	--
2	CAN_L
3	CAN_GND
4	--
5	--
6	GND B
7	CAN_H
8	--
9	UB

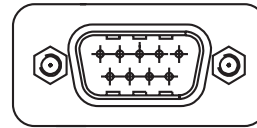

6.3. Display elements (status display)

A dual LED is integrated at the back of the bus cover.

LED green	LED red	Status
Off	Off	Power supply not connected
Flashing	Off	Pre-operational mode
On	Off	Operational mode
On	On	Stopped/Prepared mode
Off	Flashing	Warning
Off	On	Error